

Linear

# MIMI SL RGB Fixture Guide

# KKDÖ

Outdoor | Surface | RGB output



## Key applications

- ✓ Architectural detail
- ✓ Bathrooms
- ✓ Building facades
- ✓ Cabinet & furniture
- ✓ Cove lighting
- ✓ Direct lighting
- ✓ Exterior
- ✓ Hand rail
- ✓ Interior
- ✓ Mirror back lighting
- ✓ Retail display
- ✓ Shelving display
- ✓ Special effect
- ✓ Wet area

## Key features

- ✓ Adjustable
- ✓ Custom lengths
- ✓ Constant Voltage (CV)
- ✓ Diffusion: spoting
- ✓ Direct view
- ✓ Extensive CCT range
- ✓ Illuminated ends
- ✓ IP40 dry area
- ✓ IP67 waterproof
- ✓ Light on time (10 day delivery)
- ✓ RGB
- ✓ Thin light line

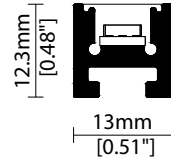

## MOUNTING METHODS



KKCP-02 Clip



KKBK-06 Fixed bracket



KKBK-05 Adjustable bracket

Linear

# MIMI SL RGB

## Specification sheet

# KKDC



<b>Dimensions</b>	H12.3/W13/L99-2016mm (H0.48/W0.51/L3.89-79.37in)
<b>PCB Cut-point</b>	83.3mm increment/2000mm max (3.28in increment/78.74in max)
<b>LED Pitch</b>	13.9mm-72LED/m (0.55in - 22LED/ft)
<b>Chip</b>	RGB
<b>Cover/Optics</b>	Clear silicone (110°)
<b>CCT</b>	Red 620-625nm/Blue 455-460nm/Green 520-525nm
<b>LED binning</b>	5nm tolerance
<b>CRI</b>	N/A
<b>Lifetime</b>	50,000 hours @ 25°C (50,000 hours @ 77°F)
<b>Operating temp</b>	T <sub>a</sub> = -25 to 50°C (T <sub>c</sub> max = 70°C) T <sub>a</sub> = -13 to 122°F (T <sub>c</sub> max = 158°F)
<b>IP Rating</b>	IP67
<b>Finish</b>	Silver anodised
<b>Mounting</b>	Surface mounting via clips or brackets
<b>Power feed</b>	Sheathed hardwire tails or male/female connectors
<b>Control</b>	DMX/DALI



Power consumption	Supply voltage	Supply current
15.6W/m (4.75W/ft)	24V DC	0.65A/m (0.20A/ft)

### Silicone Potted

Red: 113lm/m (34lm/ft)  
Green: 224lm/m (68lm/ft)  
Blue: 40lm/m (12lm/ft)  
RGB: 353lm/m (108lm/ft)

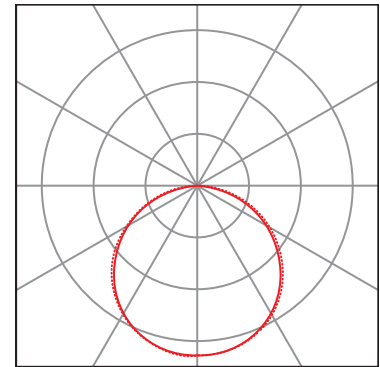
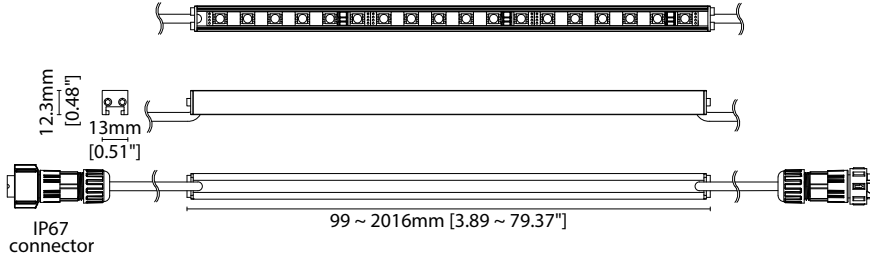

Silicone potted  
— C0 / C180      cd / 1000 lm      - - - C90 / C270

Data derived from production samples tested to UKAS/IESNA LM-79-08 standards.

See KKDC website for product document updates.

[www.kkdc.lighting](http://www.kkdc.lighting)

MIMISLRGBS-03.04EN-20250805

Linear

# MIMI SL RGB

## Code Table



### FIXTURE

Model	Finish	Cover <sup>1</sup>	Grade	LED	Colour (CCT)	Length Availability <sup>2</sup>	IP	Cable Length	Power Feed <sup>3</sup>	Input									
MIMI SL	SL	Silver Anodised	SA	No cover	X	s	501	RGB	RGB	m	99.3-2016mm 83.3mm increments	IP67	67	300mm/ 11.81"	0300	Single ø4.3mm sheath tail	S00A	DC 24V	g
						i					3.91-79.37in 3.28in increments					Double ø4.3mm sheath tail	D00A		
											(Specify length code OR total run length)					Single ø4.3mm sheath IP67 connector	S67A		
																Double ø4.3mm sheath IP67 connector	D67A		

<sup>1</sup> Refer to **Cover/Lens Options** on **Options** pages

<sup>2</sup> Refer to **Length Availability List** or enter total run length instead of length code

<sup>3</sup> Refer to **Power feed Options** on **Options** pages

### Code Example:

SL	-	SA	-	X	-	s	-	501	-	RGB	-	m	516	-	67	-	0300	-	D67A	-	g
MIMI SL		Silver Anodised		No cover				501		RGB		515.8mm		IP67		300mm/11.81"		Double ø4.3mm sheath IP67 connector		DC 24V	

### ACCESSORIES

#### Mounting Accessories

KKCP-02	Clip (1no.)
KKCP-52	Clip (500no.)
KKBK-06	Fixed bracket
KKBK-05	Adjustable bracket

\* Refer to **Mounting accessories** on **Accessories** pages

#### Connection Accessories

CN67-4P-0300	IP67 4 PIN RGB male & female 300mm/11.81" pair
CN67-4P-1000	IP67 4 PIN RGB male & female 1000mm/39.37" pair
CN67-4P-3000	IP67 4 PIN RGB male & female 3000mm/118.11" pair

\* Refer to **Power feed** on **Accessories** pages

#### Exterior Junction Boxes

KKJB-07	IP67 Slim J-Box
KKJB-07R	Potting Resin for IP67 Slim J-Box

\* Refer to **Exterior Junction Boxes** on **Accessories** pages

#### PSU/Driver

DALI/DMX

\* Refer to **Driver/PSU Options** page for details or provide requirement and KKDC to offer the suitable option

### LED ENGINE VARIANTS (LED STRIP TYPE)

Colour	LED	Lumen/m	Lumen/ft	W/m	W/ft	Spec Doc	Length	Increment
Single CCT	R007	490	149	7	2.13	MMI SL R007	99-2016mm (3.89-79.37in)	41.7mm (1.64in)
	R014	1024	312	14	4.27	MMI SL R014	99-2016mm (3.89-79.37in)	41.7mm (1.64in)
	R020	1463	446	20	6.10	MMI SL R020	99-2016mm (3.89-79.37in)	41.7mm (1.64in)
RGB	501	Red: 113 Green: 224 Blue: 40 RGB: 353	Red: 34 Green: 68 Blue: 12 RGB: 108	15.6	4.75	MIMI SL RGB	99-2016mm (3.89-79.37in)	83.3mm (3.28in)

\* Performance data: silicone potted, RGB

# MIMI SL RGB

## Length Availability List



Length Code		Fixture Length <sup>1</sup>		LED Strip <sup>2</sup>		End Cap Dimension <sup>3</sup>		Wattage (W)	Output (lm)			
Metric	Imperial(US)	Metric	Imperial(US)	Metric	Imperial(US)	Metric	Imperial(US)		R	G	B	W
m0099	i0004	99mm	3.91in	83mm	3.28in	11mm	0.43in	1.30	2	3	1	5
m0183	i0007	183mm	7.19in	167mm	6.56in	11mm	0.43in	2.60	3	7	1	10
m0266	i0010	266mm	10.47in	250mm	9.84in	11mm	0.43in	3.90	5	10	2	15
m0349	i0014	349mm	13.75in	333mm	13.12in	11mm	0.43in	5.20	6	13	2	20
m0433	i0017	433mm	17.04in	417mm	16.41in	11mm	0.43in	6.50	8	17	3	25
m0516	i0020	516mm	20.32in	500mm	19.69in	11mm	0.43in	7.80	10	20	4	30
m0599	i0024	599mm	23.60in	583mm	22.97in	11mm	0.43in	9.10	11	23	4	34
m0683	i0027	683mm	26.88in	667mm	26.25in	11mm	0.43in	10.40	13	27	5	39
m0766	i0030	766mm	30.16in	750mm	29.53in	11mm	0.43in	11.70	14	30	5	44
m0849	i0033	849mm	33.44in	833mm	32.81in	11mm	0.43in	13.00	16	33	6	49
m0933	i0037	933mm	36.72in	917mm	36.09in	11mm	0.43in	14.30	17	37	6	54
m1016	i0040	1016mm	40.00in	1000mm	39.37in	11mm	0.43in	15.60	19	40	7	59
m1099	i0043	1099mm	43.28in	1083mm	42.65in	11mm	0.43in	16.90	21	43	8	64
m1183	i0047	1183mm	46.57in	1167mm	45.94in	11mm	0.43in	18.20	22	47	8	69
m1266	i0050	1266mm	49.85in	1250mm	49.22in	11mm	0.43in	19.50	24	50	9	74
m1349	i0053	1349mm	53.13in	1333mm	52.50in	11mm	0.43in	20.80	25	53	9	79
m1433	i0056	1433mm	56.41in	1417mm	55.78in	11mm	0.43in	22.10	27	57	10	84
m1516	i0060	1516mm	59.69in	1500mm	59.06in	11mm	0.43in	23.40	29	60	11	89
m1599	i0063	1599mm	62.97in	1583mm	62.34in	11mm	0.43in	24.70	30	63	11	93
m1683	i0066	1683mm	66.25in	1667mm	65.62in	11mm	0.43in	26.00	32	67	12	98
m1766	i0070	1766mm	69.53in	1750mm	68.90in	11mm	0.43in	27.30	33	70	12	103
m1849	i0073	1849mm	72.81in	1833mm	72.18in	11mm	0.43in	28.60	35	73	13	108
m1933	i0076	1933mm	76.10in	1917mm	75.47in	11mm	0.43in	29.90	36	77	13	113
m2016	i0079	2016mm	79.38in	2000mm	78.75in	11mm	0.43in	31.20	38	80	14	118

<sup>1</sup> Actual total overall length of light fixture (LED strip + end caps + void/wire hole)

<sup>2</sup> Actual length of PCB strip

<sup>3</sup> Actual length of 2x end caps

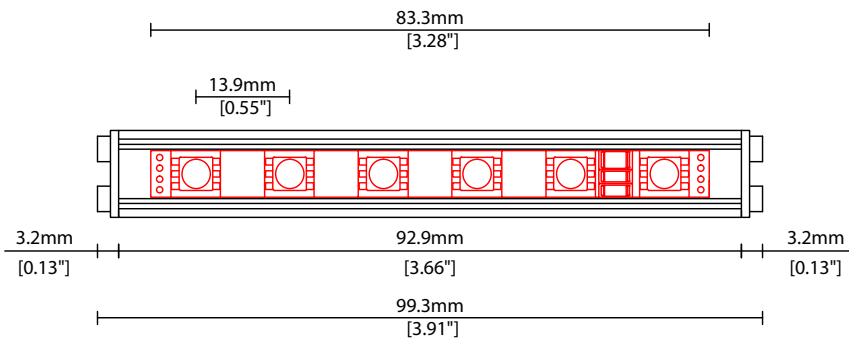



# MIMI SL RGB

## Options



### COVER/LENS OPTIONS

\* Options are an integral part of the fixture ordering codes. Please refer to **Code Table** pages.

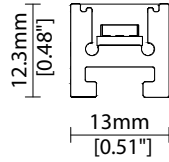

No cover (Silicone potted)  
W19.5/H38.1mm (W0.77"/H1.50")

### POWER FEED OPTIONS

\* Options are an integral part of the fixture ordering codes. Please refer to **Code Table** pages.

**0300 S00A 300mm (11.81") Single Ø4.3mm sheath tail**

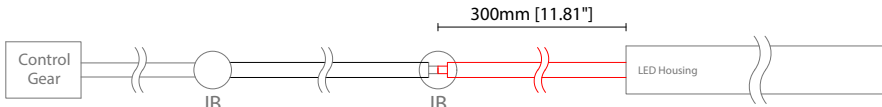

**0300 D00A 300mm (11.81") Double Ø4.3mm sheath tail**

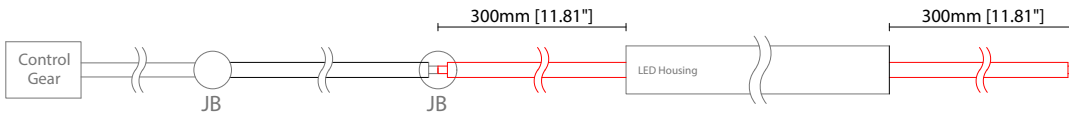

**0300 S67A 300mm (11.81") Single ø4.3mm sheath connector IP67 (Premoulded)**

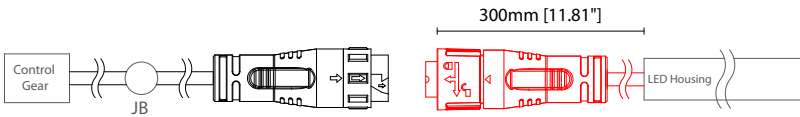

**0300 D67A 300mm (11.81") Double ø4.3mm sheath connector IP67 (Premoulded)**

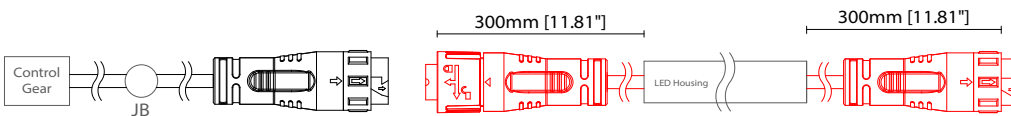

**4 Pin RGB Female Connector IP67 (Premoulded)**

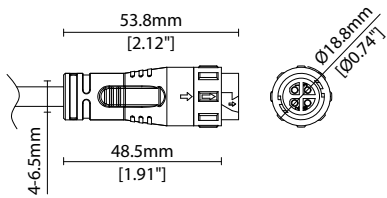

**4 Pin RGB Male Connector IP67 (Premoulded)**

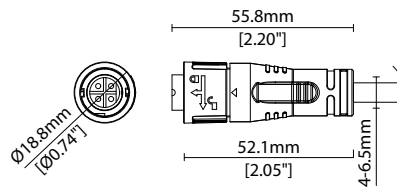

**Key**

Control Gear Power supply, sub-controllers & control systems

JB Junction box / cable connection

## MOUNTING ACCESSORIES

Note: Accessories are to be ordered separately with corresponding code shown below.



**KKCP-02** (1no.)  
**KKCP-52** (500no.)  
Clip (allow 3 per metre/40in)  
S/Steel finish  
L25/W16.7/H13.5mm  
(L0.98/W0.66/H0.53")

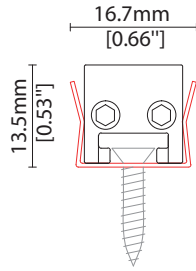

**KKBK-06**  
Fixed bracket (allow 3 per metre/40in)  
S/Steel finish  
L20/W29.1/H26.7mm  
(0.79/W1.15/H1.05")

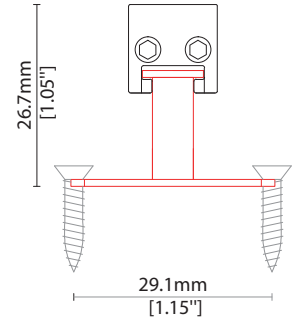

**KKBK-05**  
Adjustable bracket  
(allow 2 per metre/40in)  
S/Steel finish  
L36.5/W13/H30.9mm  
(L1.44/W0.51/H1.22")

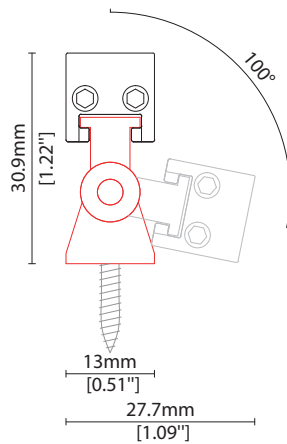

## POWER FEED

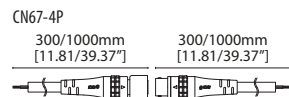

**CN67-4P-0300** 300mm (11.81in) pair  
**CN67-4P-1000** 1000mm (39.37in) pair  
IP67  
4 PIN male + female (RGB/LEDmix) connector set



**CN67-4P-3000** 3000mm (118.11in) pair  
IP67  
4 PIN male + female (RGB/LEDmix) connector set



# MIMI SL RGB Accessories



## EXTERIOR JUNCTION BOXES

---



**KKJB-07**

IP67 Slim J-Box  
(including type A,B,C,D bushings)



**KKJB-07R**

Potting resin for IP67 Slim J-Box

### KKDC CONTROL



IP20  
Plastic housing  
L170/W59/H29mm  
(L6.69/W2.32/H1.14in)

**KKDM-06** 1-10V  
visDIM dimmable sub-controller  
(4 x 8A max @ 12-36V)



IP20  
Plastic housing  
L170/W53.4/H28mm  
(L6.69/W2.10/H1.10in)

**KKSC-05** DMX  
visDIM dimmable sub-controller  
(4 x 5A max @ 12-36V)



IP20  
Plastic housing  
L170/W59/H29mm  
(L6.69/W2.32/H1.14in)

**KKDL-02** DALI  
visDIM dimmable sub-controller  
(4 x 8A max @ 12-36V)



IP20  
Plastic housing  
L166/W53.4/H23mm  
(L6.54/W2.10/H0.91in)

**KKDL-03** DALI  
visDIM dimmable sub-controller  
(4 x 5A max @ 12-36V)



IP20  
Plastic housing  
L170/W53.4/H28mm  
(L6.69/W2.10/H1.10in)

**KKDL-04** DALI-2  
visDIM dimmable sub-controller  
(4 x 5A max @ 12-36V)

### AVAILABLE PSU OPTIONS

Control Mode	PSU (Order Code)	Input Voltage AC	Output Voltage DC	Rated Output Current	Rated Power	Dim %	IP Rating
Switched	CEN-60-24	90-295V	24V	2.5A	60W	-	IP67
	HLG-60H-24	90-305V	24V	2.5A	60W	-	IP67
	HLG-100H-24	90-305V	24V	4.0A	100W	-	IP67
	HLG-150H-24	90-305V	24V	6.3A	150W	-	IP67
	HLG-240H-24	90-305V	24V	10A	240W	-	IP67
0-10V (1-10V)	PWM-40-24	90-305V	24V	1.67A	40W	100-0.15 (100-10)	IP67
	PWM-60-24	90-305V	24V	2.5A	60W	100-0.15 (100-10)	IP67
	PWM-90-24	90-305V	24V	3.67A	90W	100-0.15 (100-10)	IP67
	PWM-120-24	90-305V	24V	5.0A	120W	100-0.15 (100-10)	IP67
DALI	LIN100A1	120-277V	24V	1A per channel	100W	100-0.1	IP66/IP40
DMX RGB	LIN100A1	120-277V	24V	1.33A per channel	100W	100-0.1	IP66/IP40
DMX RGBW	LIN100A1	120-277A	24V	1A per channel	100W	100-0.1	IP66/IP40

### Flicker Free Options - Combination of PSU+ sub-controller

Control Mode	PSU (Order Code)	Sub-controller (Order Code)	Input Voltage AC	Output Voltage DC	Rated Output Current	Rated Power	Dim %	IP Rating PSU/ Sub-controller
0-10V or 1-10V	CEN-60-24	KKDM-06	90-295V	24V	2.5A	60W	100-0.9	IP67/IP20
	HLG-60H-24	KKDM-06	90-295V	24V	2.5A	60W	100-0.9	IP67/IP20
	HLG-100H-24	KKDM-06	90-295V	24V	4.0A	100W	100-0.9	IP67/IP20
	HLG-150H-24	KKDM-06	90-295V	24V	6.3A	150W	100-0.9	IP67/IP20
	HLG-240H-24	KKDM-06	90-295V	24V	10.0A	240W	100-0.9	IP67/IP20
DALI	CEN-60-24	KKDL-02/03/04/visDIM PRO 30	90-295V	24V	2.5A	60W	100-0.1	IP67/IP20
	HLG-60H-24	KKDL-02/03/04/visDIM PRO 30	90-305V	24V	2.5A	60W	100-0.1	IP67/IP20
	HLG-100H-24	KKDL-02/03/04/visDIM PRO 30	90-305V	24V	4.0A	100W	100-0.1	IP67/IP20
	HLG-150H-24	KKDL-02/03/04/visDIM PRO 30	90-305V	24V	6.3A	150W	100-0.1	IP67/IP20
	HLG-240H-24	KKDL-02/03/04/visDIM PRO 30	90-305V	24V	10.0A	240W	100-0.1	IP67/IP20
DMX RGB	CEN-60-24	KKSC-05	90-295V	24V	2.5A	60W	100-0.9	IP67/IP20
	HLG-60H-24	KKSC-05	90-305V	24V	2.5A	60W	100-0.9	IP67/IP20
	HLG-100H-24	KKSC-05	90-305V	24V	4A	100W	100-0.9	IP67/IP20
	HLG-150H-24	KKSC-05	90-305V	24V	6.3A	150W	100-0.9	IP67/IP20
	HLG-240H-24	KKSC-05	90-305V	24V	10.0A	240W	100-0.9	IP67/IP20

<sup>1</sup> The items shown above cover the most frequently used specification but does not exhaust the possible options

<sup>2</sup> PSU and/or driver can be chosen from the table, or KKDC may recommend the best option upon receipt of the controls requirement and installation environment

<sup>3</sup> Electrical shop drawing will include detailed information of PSU and relevant control drivers

<sup>4</sup> Cut sheets are available on the controls section of [www.kkdc.lighting](http://www.kkdc.lighting) or upon request